

[eur]



 dazato®

[eur]





Nel legno le radici dell'eleganza. Eur, una collezione di mobili protagonisti in ogni spazio al livello direzionale, affascinanti nello stile sobrio di gusto classico, versatili nelle dimensioni e nell'utilizzo. Forme ricercate per funzioni essenziali con presenza d'insieme forte e determinante. Viene proposto nelle versioni in legno noce o wengè.

The roots of elegance in the wood. Eur, a collection of furniture which plays a leading role in every directional space, charming in its sober style with classic taste, versatile in dimensions and use. Refined shapes for essential roles, with a strong and determining presence. Available in the walnut or wengè finishes.



Linearità, qualità, attenzione ai particolari di stile, contraddistinguono l'intero programma proponendo varie soluzioni di scrivanie, mobili direzionali e librerie di un alto livello in grado di soddisfare ogni esigenza estetica e di utilizzo in ambienti personalizzati. L'organizzazione dello spazio viene interpretata proponendo diverse tipologie di piani, dritto, curvo, con inserto in pelle, allungo frontale o laterale e piani di servizio.

Linearity, quality, attention on stylistic details, feature the entire program, suggesting various solutions of high level desks, cupboards and bookcases that are able to satisfy every aesthetic need and the use in personalized environments.

Space organization is expressed by suggesting different typologies of worktops: straight, curved, with leather insert, side return table and frontal extractable extension.







La personalità unica del programma viene sottolineata con la proposta e utilizzo di due essenze di tonalità legno, noce e wengè. Una scelta estetica sobria e determinata che conferisce alla collezione un gusto classico ed esclusivo.



The unique personality of the program is underlined with the use of two types of wood, walnut and wengè. A sober and resolute aesthetic choice that gives the collection a classic and exclusive taste.















La costante ricerca di materiali accuratamente selezionati, un continuo accento al gusto raffinato e lo stile essenziale e inconfondibile di ogni elemento, valorizzano l'intera collezione per una valida proposta di arredo di ufficio direzionale.

The constant research of accurately selected materials, a continuous emphasis on refined taste and the essential and indisputable style of every element, enhance the whole collection to give a valuable proposal of directional office furnishing.

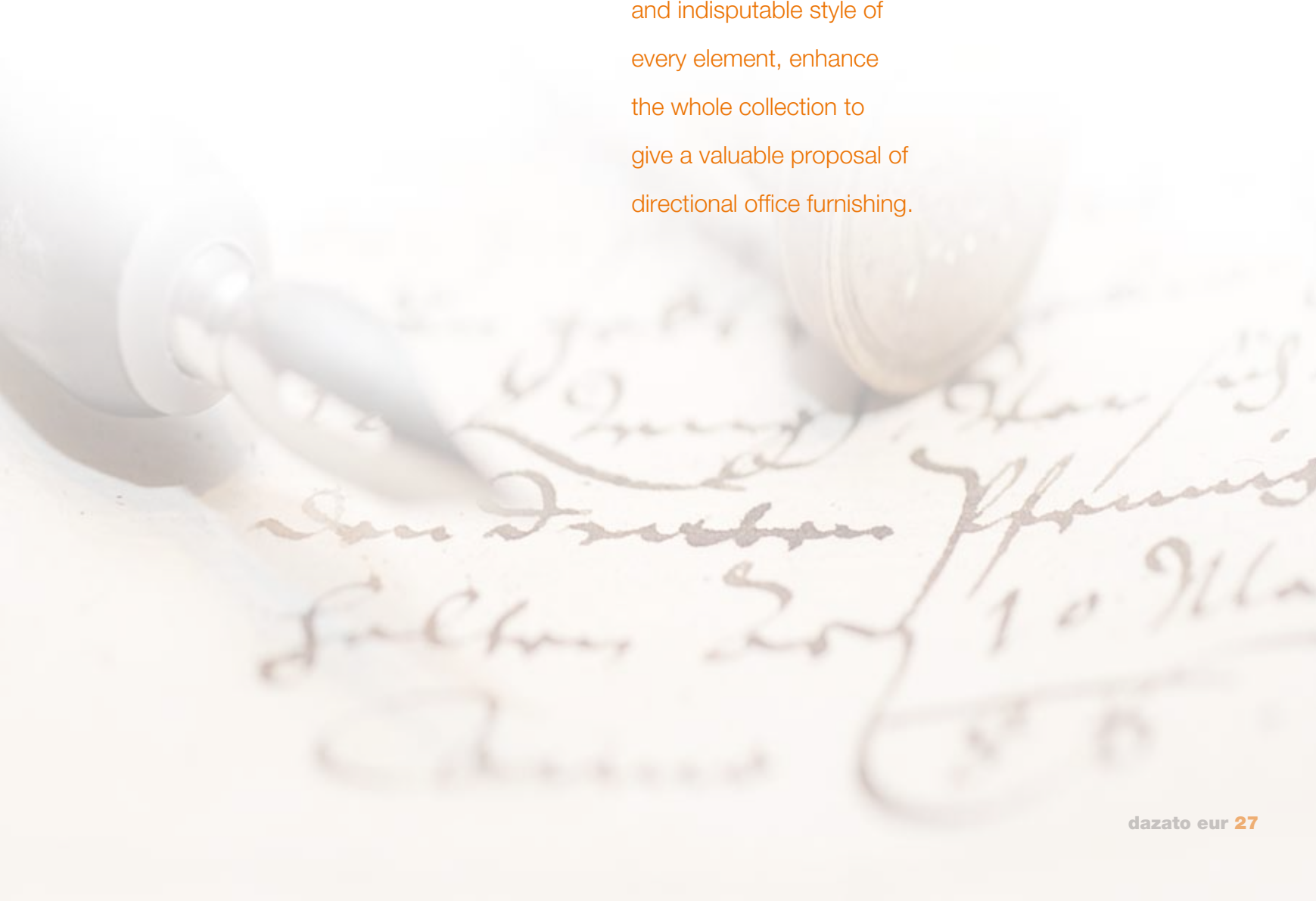





Il sistema libreria Eur nasce dal concetto di una modularità totale. Essenziale nelle linee dalla forma geometrica modulare, svolge il ruolo di inter-parete e di contenitore polifunzionale.

The Eur bookcase system originates with the concept of total modularity. Essential in its modular geometric shape, it plays the role of partition wall and multipurpose case.













Il sistema libreria Eur è caratterizzato dall'estrema flessibilità di composizione, adatto a soddisfare tutte le esigenze in termini di spazio con stile, funzionalità e razionalità. È composto strutturalmente da montanti, schienali e ripiani e da una serie di originali accessori di completamento.

The Eur bookcase system is characterized by a large flexibility in compositions, suitable to meet every exigency of space with style and functionality. Its structure is made of central and final sides, back panel, shelves and completed by original completion accessories.





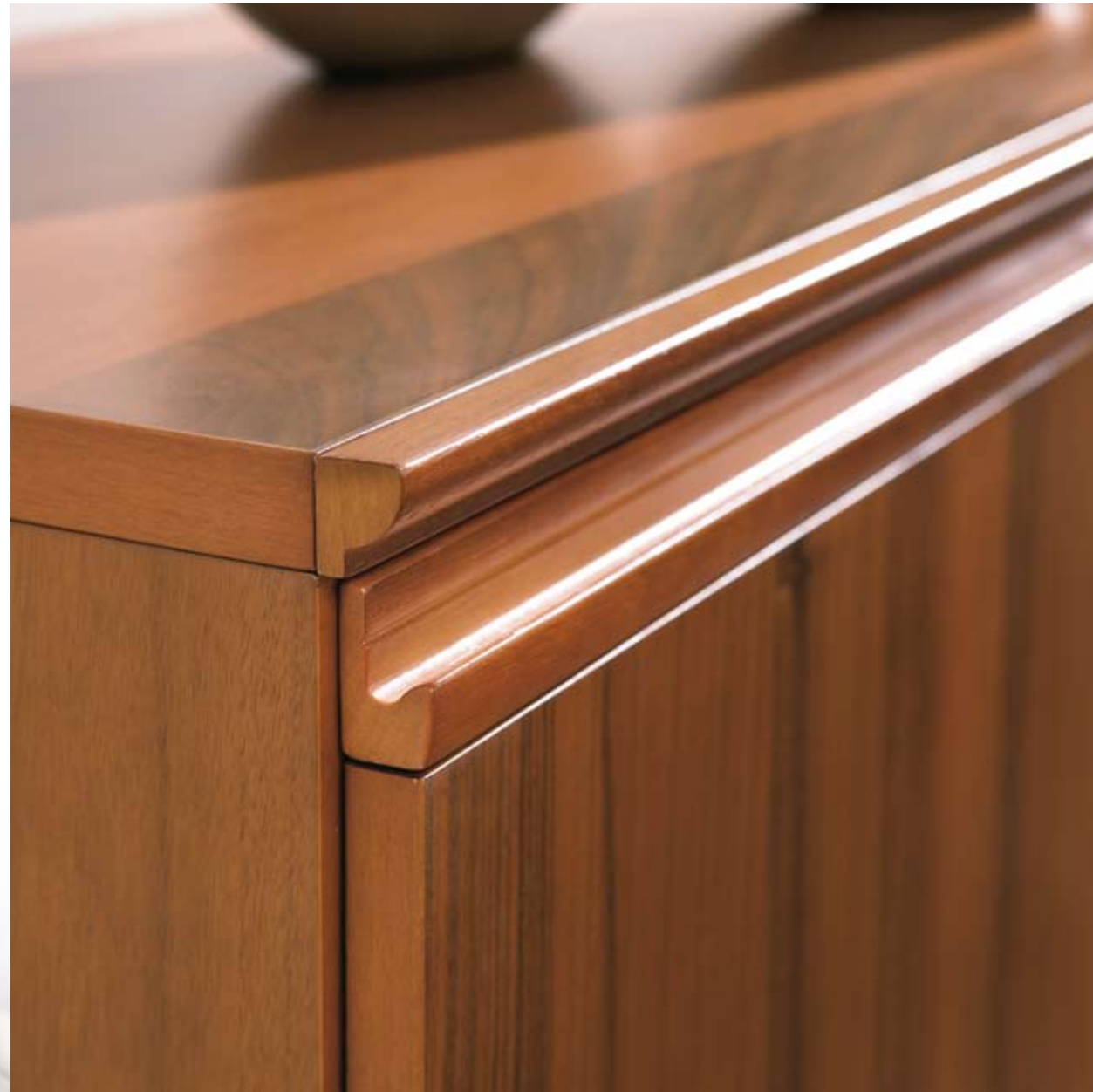

Noce - Walnut



Wengè - Wengè



Jazz poltrona, divano due posti, divano tre posti. Classicità nello stile, alto livello di comfort per pause creative, incontri e confronti. Linea pura e rigore costruttivo per un effetto di notevole eleganza. Un progetto di

precisione costruttiva che si fonde con creatività ed intuizione. Il piacere di sedersi grazie ad una forma volumetrica ideale.



Jazz armchair, two-seater sofa, three-seater sofa. Classical style, high comfort level for creative breaks and meetings. Simple but rigorous line for an effect of notable elegance. A project of high precision that combines

creativity and intuition. The pleasure of sitting thanks to an ideal volumetric shape.



La poltrona **Dico Wood** è caratterizzata dal bracciolo imbottito abbinato al legno massiccio che sottolinea con gusto le forme estetiche decise, raffinate ed affidabili. Tutte le regolazioni sono azionate da pulsanti incorporati nella scocca di base, che evidenziano la compattezza e l'eleganza della poltrona. Il profilo esterno del bracciolo imbottito e la base girevole sono realizzati in legno massiccio verniciato nelle finiture del noce o wengè.

The **Dico Wood** chair features padded armrests matched with solid wood that tastefully underlines the clear, refined and reliable styling. All adjustments are activated by push buttons incorporated in the frame, which exalts the compact and elegant lines of the chair. The profile of the padded armrests and the rotating base are in solid wood painted with a walnut or wengè finish.



Scrivanie - Desks

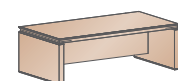

E200 200x100x75
E230 230x100x75

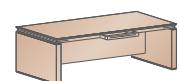

E202 200x100x75
E232 230x100x75



E201 200x100x75
E231 230x100x75

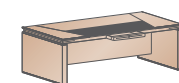

E203 200x100x75
E233 230x100x75



EC201 200x110x75
EC231 230x110x75

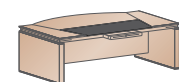

EC203 200x110x75
EC233 230x110x75

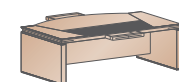

EC204 200x110x75
EC234 230x110x75

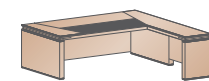

EA201 200x220x75 d/s
EA231 230x220x75 d/s

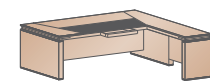

EA203 200x220x75 d/s
EA233 230x220x75 d/s

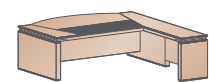

EAC201 200x230x75 d/s
EEAC31 230x230x75 d/s

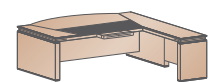

EAC203 200x230x75 d/s
EAC233 230x230x75 d/s

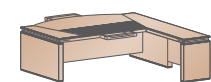

EAC204 200x230x75 d/s
EAC234 230x230x75 d/s

Tavoli, cassettiere e mobili di servizio Tables, pedestals and service units



ER130 134x134x75



ER231 234x124x75

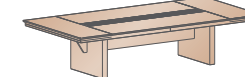

ER301 300x124x75

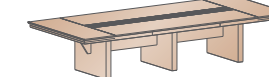

ER341 344x124x75

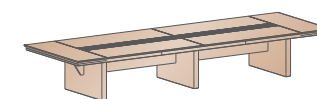

ER441 444x124x75

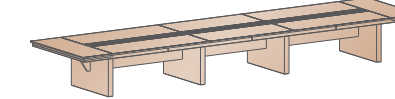

ER601 600x124x75



EC70 74x74x40



EC120 124x64x40



EA01 130x90x75



EA02 130x90x75



EC443
43x56x61



EC243
43x56x61



EC543
43x56x61



EM493D/S
87x56x61



EM494D/S
87x56x61frigo-fridge

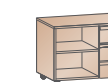

EM293D/S
87x56x61



EM393D/S
87x56x61



EM394D/S
87x56x61frigo-fridge



EM5143
130x56x61



EM5144
130x56x61frigo-fridge

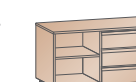

EM6143
130x56x61



EM7143
130x56x61



EM7144
130x56x61frigo-fridge

Piano spessore 73 mm composto da piano superiore impiallacciato e massellato, e piano inferiore in tamburato massellato. Le scrivanie sono disponibili nella versione piano dritto o curvo, lunghezza 200/230 cm, con sottomano rivestito, cassetto, piano di servizio e allungo laterale o frontale.

73 mm th. worktop made up of a higher veneered panel with solid wooden border, and a lower panel in honey combed infill with solid wooden border. Desks are available with straight or curved top, a length of 200 or 230 cm, with leather insert, drawer, frontal extractable extension, and frontal or side return table.

I tavoli riunione variano nelle lunghezze a partire da cm 134 fino ad arrivare a cm 600 e possono essere predisposti per la canalizzazione.

Le cassettiere ed i mobili di servizio, interamente in legno e contraddistinti dal particolare massello, sono realizzati combinando i vani a giorno con le antine in legno, cassetti, classificatori; può essere inserito anche il frigo bar.

Conference tables vary in length from cm 134 up to cm 600 and can be preset for canalization.

Pedestals and service units, wholly made in wood and characterized by the particular solid wooden border, are realized matching open sides with wooden doors, drawers and filing cabinets; a fridge unit can be included.

Mobili in legno-melaminico - Mobili in legno
Wooden-melamine cupboards - Wooden cupboards

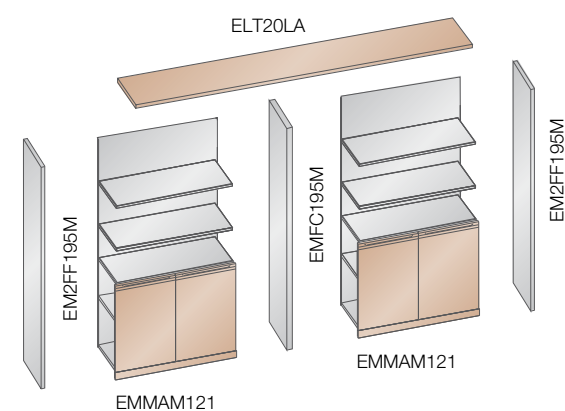

Mobile con fianchi finali e fianco centrale in melaminico
 Cupboard with melamine final and central side panels

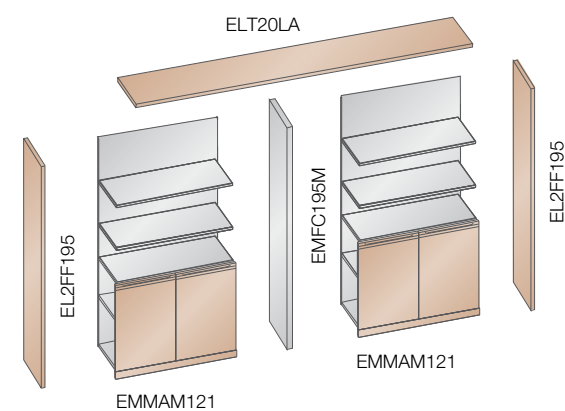

Mobile con fianchi finali in legno e fianco centrale in melaminico
 Cupboard with wooden final panels and melamine central side panel

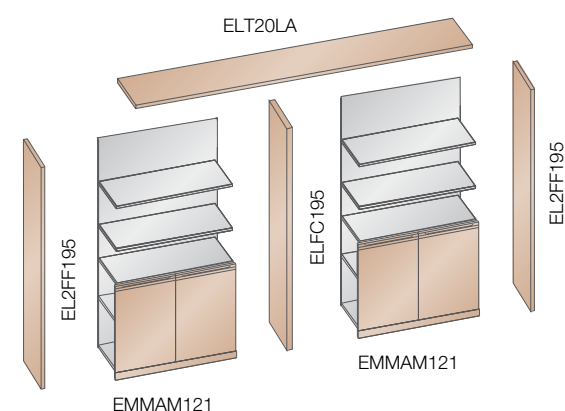

Mobile con fianchi finali e fianco centrale in legno
 Cupboard with wooden final and central side panels

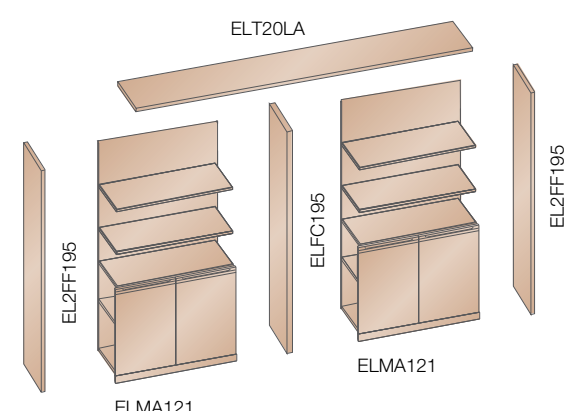

Mobile completo in legno
 Complete cupboard in wood

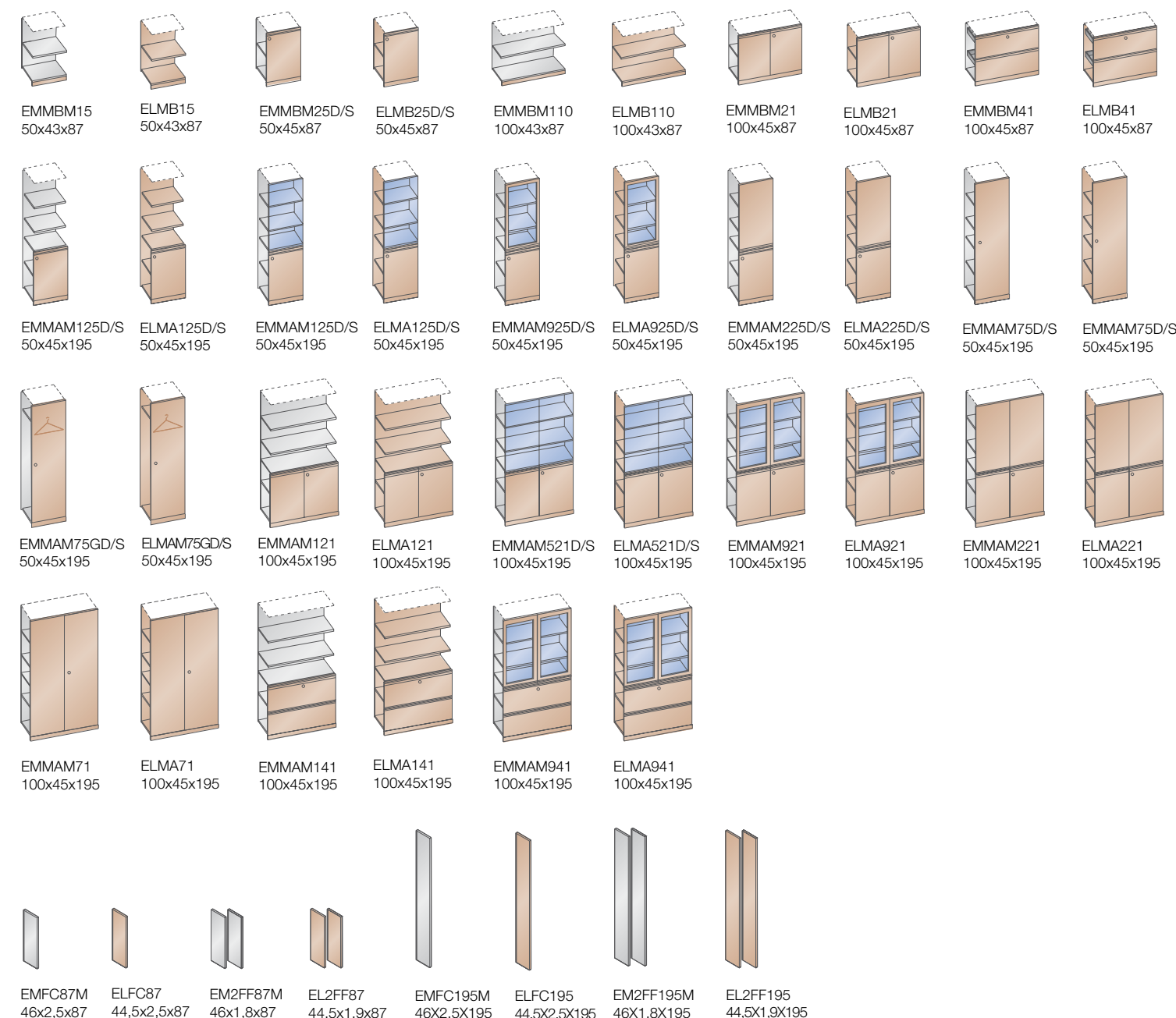

Top in legno-Wooden tops

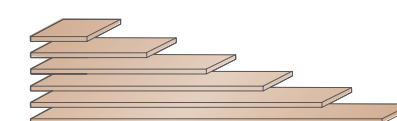

Mobile basso
Low unit

Mobile alto
High unit

- ELT 5L 51,5x45x2,6
- ELT10L 101,5x45x2,6
- ELT15L 151,5x45x2,6
- ELT20L 201,5x45x2,6
- ELT25L 251,5x45x2,6
- ELT30L 302x45x2,6

Top in legno con massello-Wooden tops with solid wooden border

Mobile basso
Low unit

Mobile alto
High unit

- ELT 5LM 51,5x43x2,6
- ELT10LM 101,5x43x2,6
- ELT15LM 151,5x43x2,6
- ELT20LM 201,5x43x2,6
- ELT25LM 251,5x43x2,6
- ELT30LM 302x43x2,6

Mobili in legno-melaminico sono realizzati con interni in melaminico (base, ripiani, cielo e schiena) e fianchi centrali e finali in melaminico o legno, che possono essere combinati a piacimento. La composizione va sempre completata con top in legno spessore 2,6 cm.

Wooden-melamine cupboards made with structure in melamine (base, shelves, top and back panel) and central and final sides in melamine or wood, that can be matched at will. The composition has always to be completed by a wooden top thickness 2,6 cm.

Mobili in legno sono realizzati interamente in legno (noce nazionale, wengè), e vanno completati da relativi fianchi centrali, finali e top in legno spessore 2,6 cm.

Wooden cupboards wholly in wood (national walnut, wengè) and completed by central panels, final side panels and wooden tops thickness 2,6 cm.

Componenti librerie modulari
Components of modular bookcases



Le librerie sono modulari. Ogni singolo vano può essere lungo 43, 86 o 129 cm e alto 42, 79, 116, 153, 190, 227, 264 o 300 cm. La libreria dispone di cassetti, classificatori, ante legno, vetro, o vetro cornice alluminio nelle versioni con chiusura a battente o a libro. I ripiani possono essere in legno sp. 4,1 o 2,6 cm, oppure in metallo sp. 1,5 cm. La libreria può essere fornita con o senza schiena, in legno rifinito oppure laccato.

Bookcases are modular. Every single case can be 43, 86 or 129 cm long and 42, 79, 116, 153, 190, 227, 264 or 300 cm high. The bookcase furnishes drawers, filing cabinets, wooden doors, glass doors or glass doors with aluminium frame, double or folding doors. Shelves can be in wood th. 4,1 or 2,6 cm, or in metal th. 1,5 cm. The bookcase can be furnished with or without back panel, in veneered wood or lacquered wood.

Componenti librerie modulari
Components of modular bookcases



Componenti librerie modulari
Components of modular bookcases

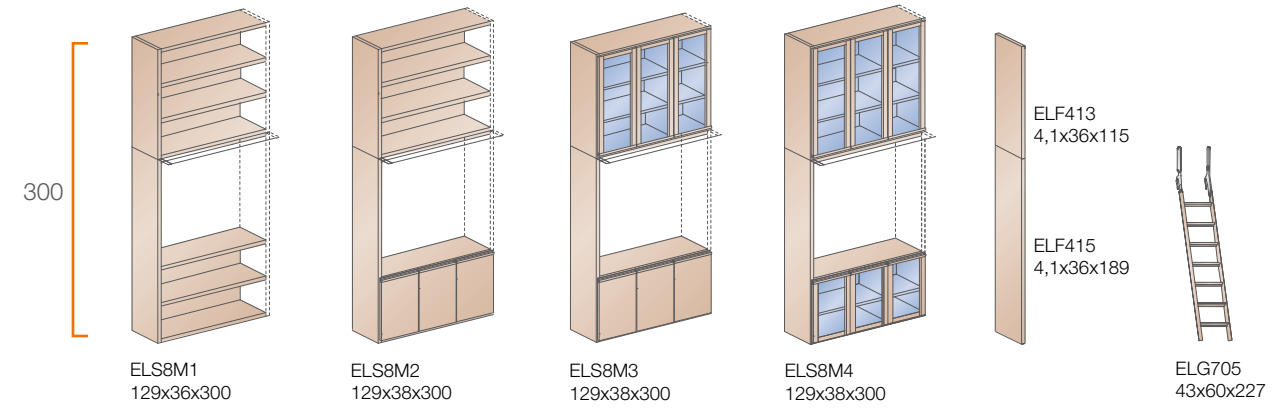
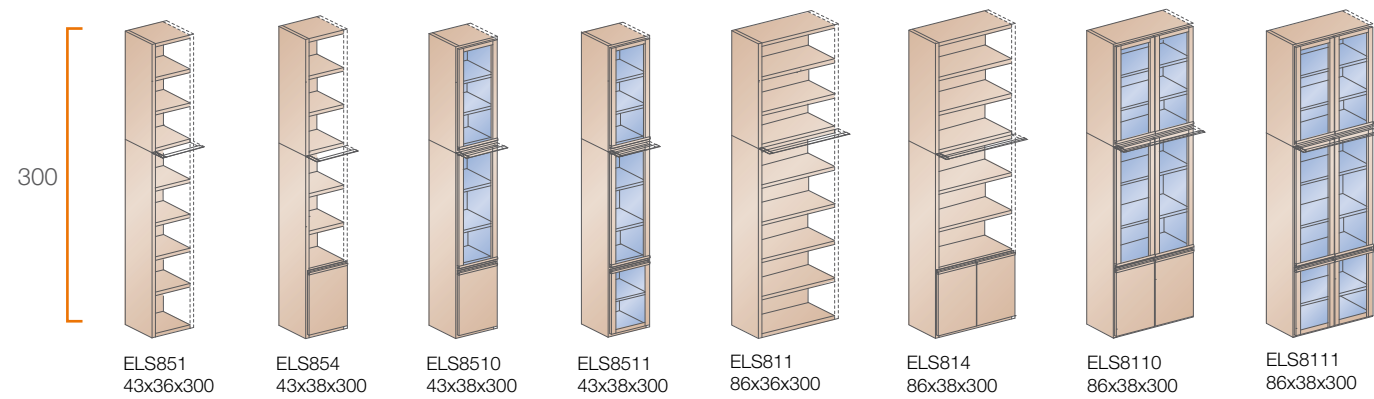
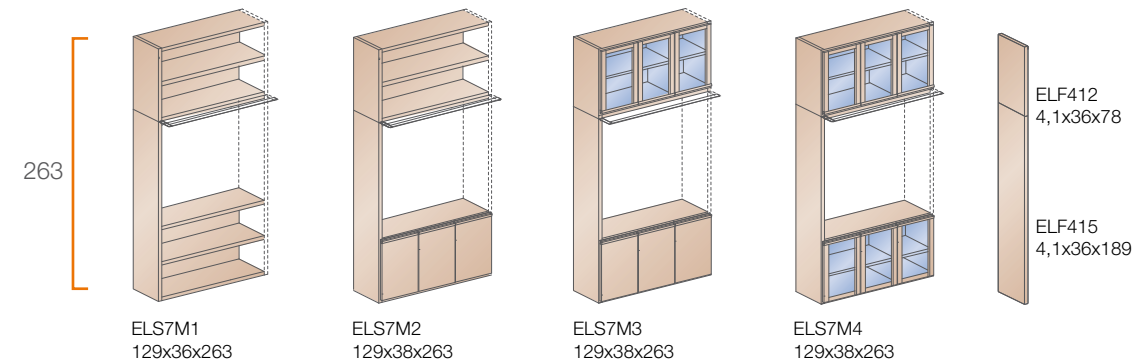
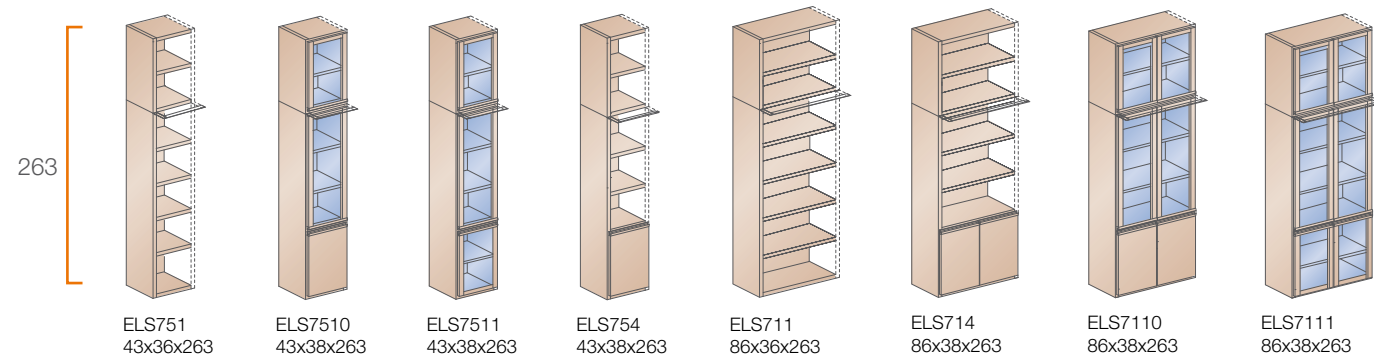
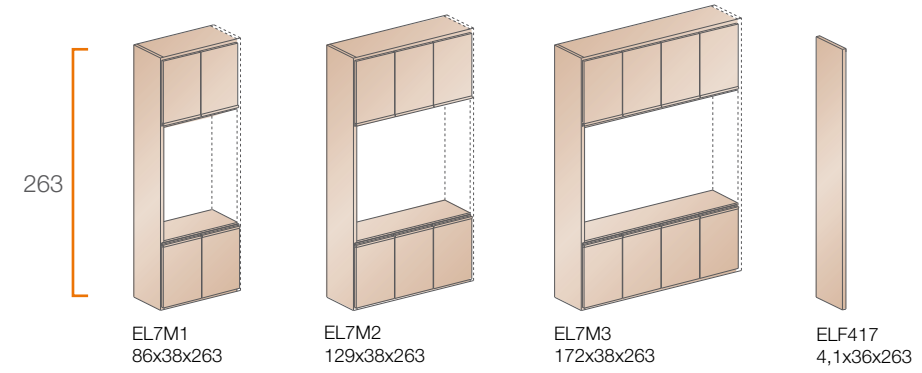
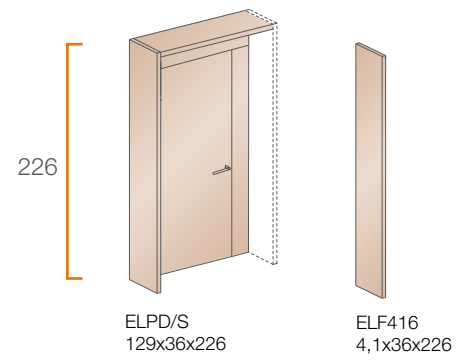

Cassettiere interne - Internal pedestals



Ripiani in legno - Wooden shelves

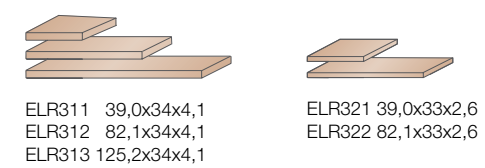

Top in legno - Wooden tops

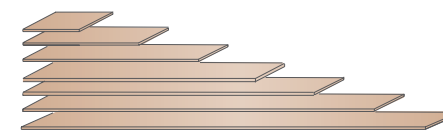

**Per libreria bassa e per alta
 Low unit / high unit**

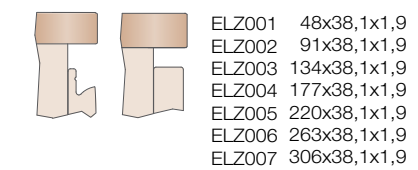

Top in legno con massello - Wooden tops with solid wooden border
 Per libreria da h 41 a h 189
 Unit from h 41 to h 189

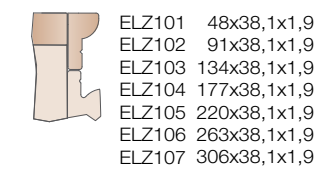

**Per libreria da h 226 a h 300
 Unit from h 226 to h 300**

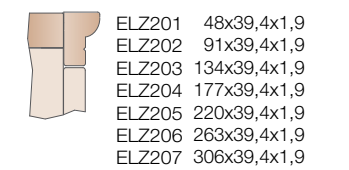

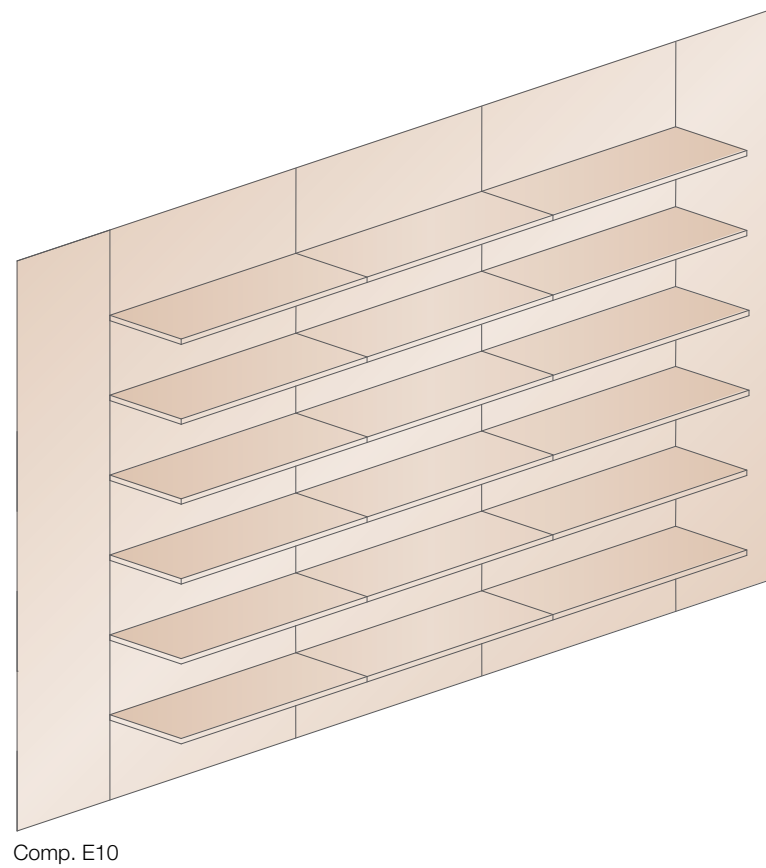

Comp. E10

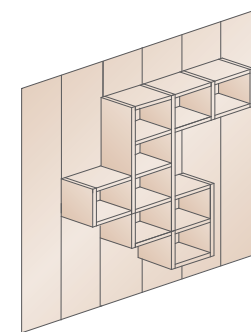

Comp. E1

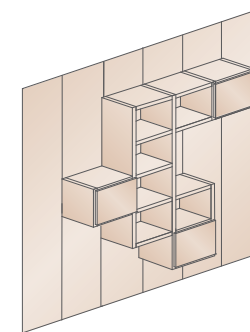

Comp. E2

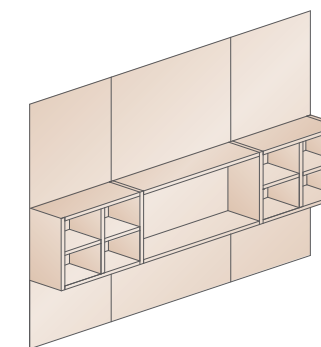

Comp. E3

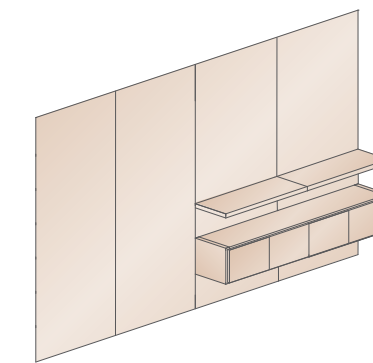

Comp. E4

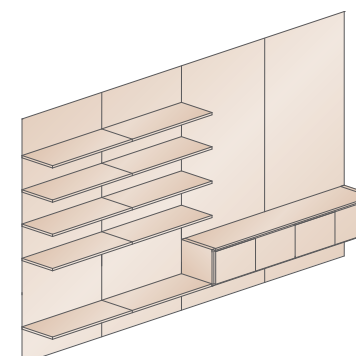

Comp. E5

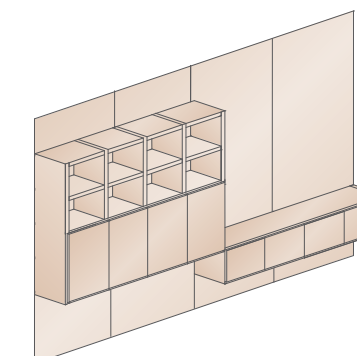

Comp. E6

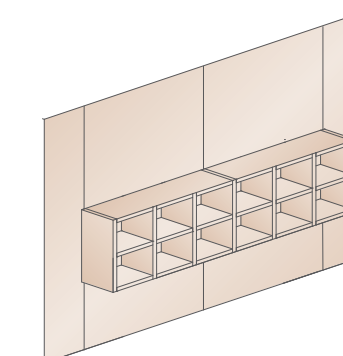

Comp. E7

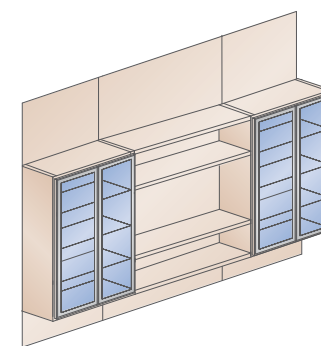

Comp. E8

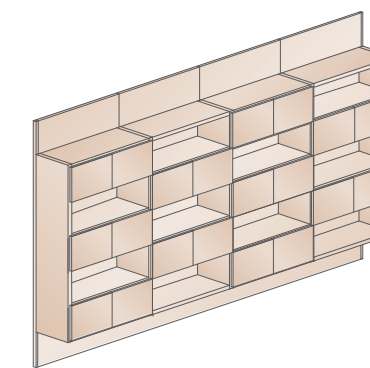

Comp. E9

Per il rivestimento di pareti tramite boiserie in legno vengono utilizzati pannelli delle stesse lunghezze dei moduli libreria (43, 86 o 129 cm), agganciati al muro grazie a dei profili in alluminio. Alla boiserie possono essere appesi ripiani oppure la libreria sospesa.

Wooden boiserie covers the office walls thanks to wooden panels that have the same length of the bookcases modules (43, 86 or 129 cm), and are attached to the wall by aluminium profiles. To the boiserie you can add shelves or the hanging bookcase.

Dazato è una azienda specializzata nella produzione di mobili e poltrone per ufficio e collettività. L'intera attività aziendale è indirizzata verso una costante innovazione dei modelli e una accurata esecuzione in ogni particolare. I prodotti sono caratterizzati da una notevole qualità nei componenti impiegati, nelle finiture adottate in ogni particolare, nella funzionalità ergonomica e nel design inteso come sviluppo di forma e funzione del prodotto. Dazato si riserva la facoltà di apportare tutte le modifiche necessarie, migliorie tecniche e formali, che ritiene opportuno per migliorare i propri prodotti, in qualsiasi momento e senza alcun preavviso. Le tonalità di colore relative alle finiture delle essenze legno sono puramente indicative e non impegnano il produttore.

Dazato is a Company specialized in the production of office and community furniture and armchairs. Its whole line of business aims to a constant innovation of models and to an accurate execution of every detail. All products are distinguished by their noteworthy quality of components used, of finishings adopted in every detail, of ergonomic functionality and of design, which includes the product shape and role. Dazato reserves the right to make any changes, technical and formal improvements, that are required to better its products, at any time and without notice. Colour tones of wood finishings are purely as an indication and do not bind the manufacturer.



Azienda con sistema di qualità certificato
Company with certified quality system



Dazato Uffici Professionali
Via P. Amalteo, 4
31020 San Fior Treviso Italy
Tel. ++ 39 0438 260 198
Fax ++ 39 0438 260 274
info@dazato.it - www.dazato.it